

KENWOOD

KAC-726
KAC-526X

POWER AMPLIFIER

INSTRUCTION MANUAL

KENWOOD CORPORATION

Safety precautions

▲WARNING

Take the following precautions to prevent fire and avoid personal injury :

- When extending the battery cable, or ground cable, use 5mm² (AWG10) or larger automotive grade cable to avoid cable deterioration or damage to the covering.
- Check that no metal objects (coins, tools, etc.) are left inside the unit to avoid short circuits.
- If you smell or see smoke, turn the power off immediately and consult your Kenwood dealer.
- Do not touch the unit during use because the surface of the unit becomes hot and may cause burns if touched.

▲CAUTION

Take the following precautions to keep the unit in proper working order.

- Be sure the unit is connected to a 12V DC power supply with a negative ground connection.

- Do not open the top or bottom cover.
- Do not install the unit in places it is exposed to direct sunlight, high heat or humidity, water may splash over it, or dust exists.

NOTE

If you have difficulty in installing this unit in your vehicle, contact your Kenwood dealer.









Cleaning the unit

If the surface is dirty, wipe it clean with a silicon cloth or soft dry cloth with the power off.

▲CAUTION

Do not use hard cloths or paint thinner, alcohol, or other volatile solvents. These may damage external surfaces or remove indicator characters.

Accessories

Part name	External View	Number of Items	Part name	External View	Number of Items
Battery cable (Yellow) (6 m)		1	Round terminal (Large)		1
Ground cable (Black) (1 m)		1	Round terminal (Medium)		2
Self-tapping screws (ø4 × 16 mm)		4	Round terminal (Small)		1
Terminal cover (Power terminal)		1	Grommets		1

Installation procedure

1. Remove the ignition key and disconnect the negative ⊖ terminal of the battery to prevent short circuits.
2. Set the unit according to the intended usage.
3. Connect the input and output cables of the units.
4. Connect the speaker cables.
5. Connect the power cable, power control cable and grounding cable following this order.
6. Install the unit in the car.
7. Connect the negative ⊖ terminal of the battery.

▲CAUTION

- Be sure to turn the power off before changing the setting of any switch.
- If the fuse blows, check cables for shorts, then replace the fuse with one of the same rating.
- Check that no unconnected cables or connectors are touching the car body. Do not remove caps from unconnected cables or connectors to prevent short circuits.
- Connect the speaker cables to appropriate speaker connectors separately. Sharing the negative cable of the speaker or grounding speaker cables to the metal body of the car can cause this unit to fail.
- After installation, check that the brake lamps, wipers, and wipers work properly.

Installation

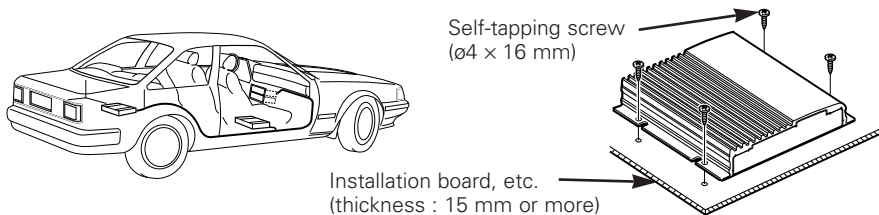

- Since the power amplifier has no parts which require operation, it can be installed at a position away from the driver's seat without any hindrances. As generally accepted positions for its installation, places such as inside the trunk, etc. can be considered.
- Use the extension cables. (Optional.)

Type	Length	0.5m	1m	2m	4m	5m	6m
RCA cable		CA-2SL	CA-12SL	CA-22SL	—	CA-52SL	—
RCA cable (ø7mm)		CA-3WL	CA-13WL	CA-23WL	—	CA-53WL	—
RCA cable (ø12mm)		CA-5W	CA-15W	CA-25W	CA-45W	—	CA-65W

▲CAUTION

- Do not install the unit under the carpet. Otherwise heat build-up occurs and the unit may be damaged.
- Install this unit in a location which allows heat to easily dissipate. Once installed, do not place any object on top of the unit.
- After installing the unit, check to make sure that electrical equipment such as the brake lamps, turn signal lamps and windshield wipers operate normally.
- Install the unit securely in a location that does not interfere with driving.

Controls

Operations of the following control and switches are required in accordance with the center unit and speakers connected with this unit.

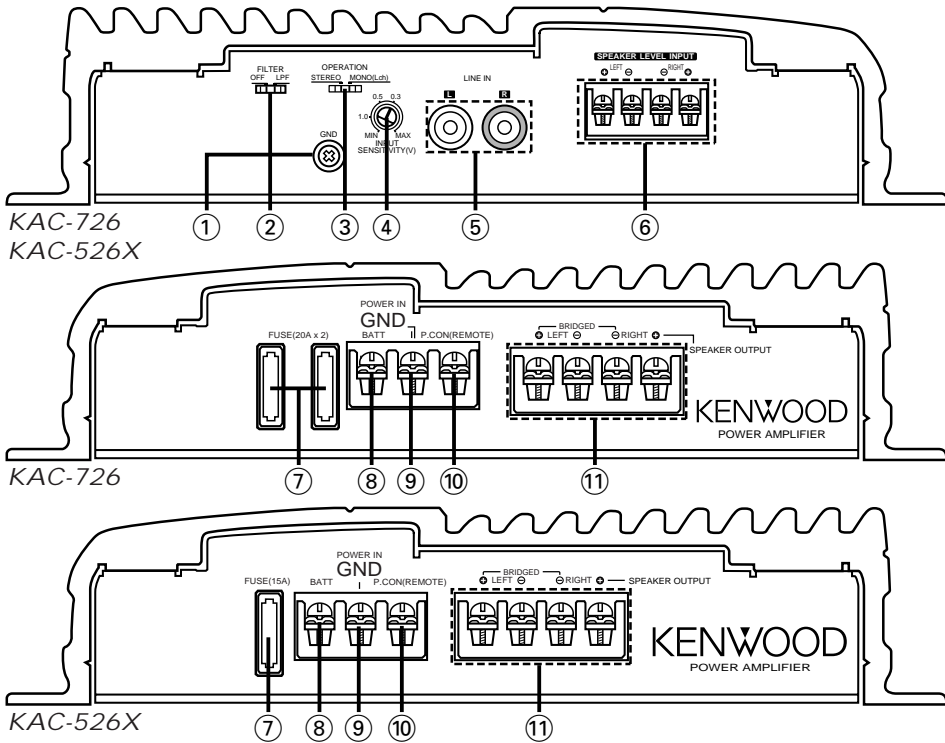

① RCA cable ground lead terminal

② FILTER switch

These switches allow filtering of the speaker output signals.

• **LPF (Low Pass Filter) position**

Only frequencies of 80 Hz or lower are output. (Frequencies above 80 Hz are cut.)

The Lch and Rch will be mixed before output even if the operation switch is set to STEREO.

• **OFF position**

The original sound without filtering is output.

③ OPERATION switch

This switch allows selection of the amplification method of input signals.

• **STEREO position**

The amplifier can be used as a stereo amplifier.

• **MONO (Lch) position**

Amplifies the signal input from the left side only. Set to this position and make bridged connections to use as a high-power monaural amplifier. (The input right signal is not output.)

④ INPUT SENSITIVITY control

Set this control according to the pre-output level of the center unit connected with this unit, or to the maximum power output of the genuine-accessory car stereo.

Use the diagram on the right as a guide.

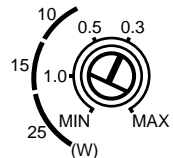

NOTE

For the pre-output level or the maximum power output, refer to the "Specifications" in the instruction manual of the center unit.

- ⑤ *LINE IN terminal*
- ⑥ *Speaker level input terminals*
- ⑦ *Fuse (20 A × 2 : KAC-726)
(15 A : KAC-526X)*
- ⑧ *Battery terminal*
- ⑨ *Ground terminal*
- ⑩ *Power control (REMOTE) terminal*
- ⑪ *SPEAKER OUTPUT terminals*

Protection function

This unit is equipped with a protection function for protecting this unit and your speakers from various accidents or problems that can occur.

When the protection function is triggered, the Power indicator goes off and the amplifier stops operating.

■ ***Power indicator:***

When the power is turned on, the Power indicator lights.

If the Power indicator does not light when the power is turned on, the protection function may be activated. Check whether there is any indication of trouble.

■ ***The protection function activates in the following situations:***

- When a speaker output contacts ground.
- When the unit malfunctions and a DC signal is sent to the speaker output.
- When the temperature of internal parts exceeds 120°C (248°F).
- When a ground cable of the center unit (cassette receiver, CD receiver, etc.) or this unit is not connected to a metal part serving as an electrical ground passing electricity to the battery's negative ⊖ terminal.

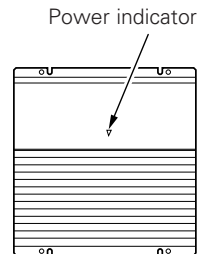

Connection

RCA cable connection

▲CAUTION

Do not connect cables and leads to both RCA cable input jacks and the speaker input terminals simultaneously, for this may cause malfunction or damage.

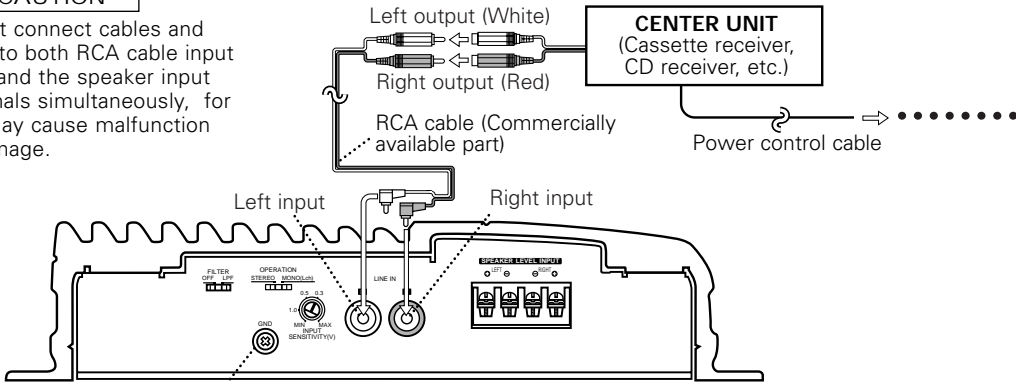

RCA cable ground terminal

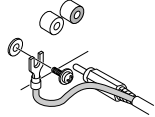

When using an RCA cable with a ground lead attached, connect the ground lead to this terminal.

▲CAUTION

Do not use this terminal for power source grounding. This unit will be damaged if the power source grounding wire is connected to this terminal.

Speaker level input connection

Connect the unit by inserting it in the connection between the genuine-accessory car stereo and speakers.

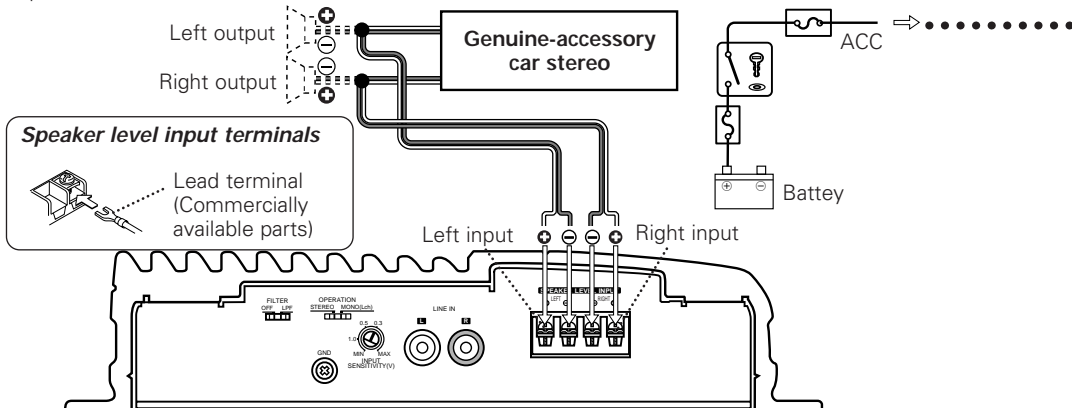

▲CAUTION

- The genuine-accessory car stereo shall have a maximum power output of no more than 25 W.
- Do not connect the speaker output leads from a power amplifier (Optional) to the speaker input terminals of this unit, for this may cause malfunction or damage.
- Do not connect cables and leads to both RCA cable input jacks and the speaker input terminals simultaneously, for this may cause malfunction or damage.
- Connect the power control lead to a power supply which can be turned ON/OFF by the ignition key switch (ACC line).

With this connection, shock noise may be generated when the power of the genuine-accessory car stereo is switched ON/OFF.

■ Power and Speakers cable connection

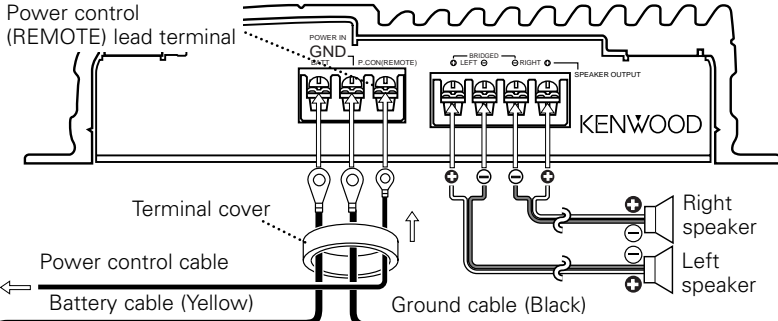

- If a buzzing noise is heard from the speakers when the engine is running, connect a line noise filter (optional) to each of the battery cable.
- Do not allow the cord to directly contact the edge of the iron plate by using Grommets.

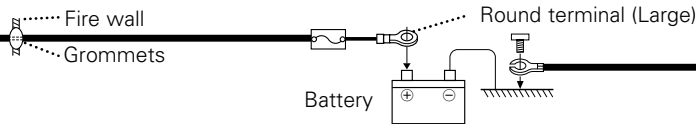

NOTE

Connect the ground cable to a metal part of the car chassis that acts as an electrical ground passing electricity to the battery's negative \ominus terminal. Do not turn the power on if the ground cable is not connected.

⚠ WARNING

To prevent fire caused by a short in the wiring, connect a fusible link or breaker nearby the battery's positive terminal.

Speaker output cable terminal

Connect the speaker output cables to these terminals.

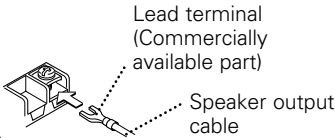

Power terminal

Pass battery and ground cables through supplied terminal cover and connect to respective terminals. After completing connections, fasten terminal cover over terminal bracket.

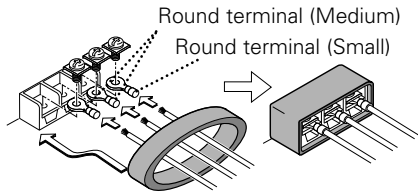

(Bridged)

⚠ CAUTION

If you wish to bridge-connect a speaker, the speaker impedance must be no less than 4 ohms.

Connecting a speaker with an impedance lower than 4 ohms may damage the unit.

examples:

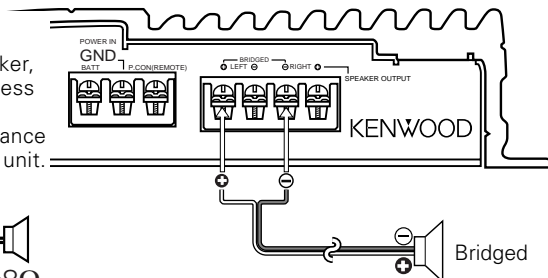
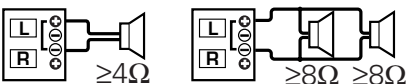

System examples

Full-range 2-channel system

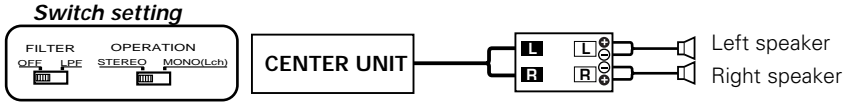

High-power full-range 2-channel system

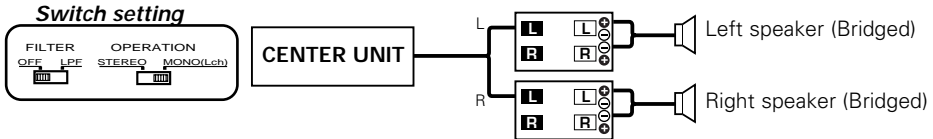

Full-range 2-channel + Subwoofer system

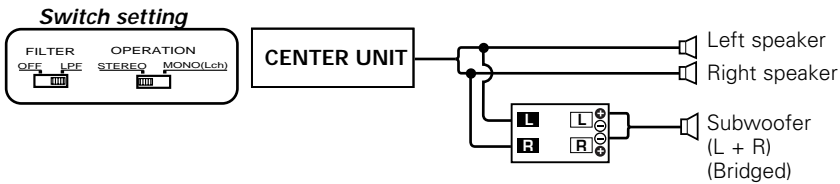

Tri-mode

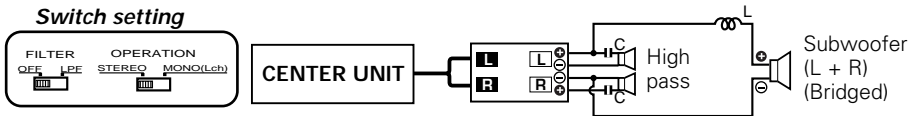

Principle of Tri-mode

Method of frequency band division using a coil and capacitor...in case of 6dB/oct. slope

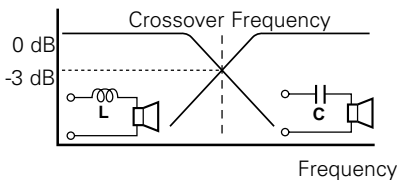

Coil (L): Passes low frequencies and blocks high frequencies. (Low pass)

Capacitor (C): Passes high frequencies and blocks low frequencies. (High pass)

$$C = \frac{159000}{f_c \times R} \text{ (}\mu\text{F)}$$

$$L = \frac{159 \times R}{f_c} \text{ (mH)}$$

f_c = Cut of Frequency (Hz)
 R = Speaker Impedance (Ω)

Example:

When it is required to set a crossover frequency of 120 Hz using speakers with an impedance of 4 ohms.

Prepare commercially-available coil and capacitor with the closest ratings to the results calculated from the formula above. The capacitor rating should be as close as possible to 331.25 (μ F) and the coil rating should be as close as possible to 5.3 (mH).

CAUTION

If you wish to bridge-connect a speaker, the speaker impedance must be no less than 4 ohms. Connecting a speaker with an impedance lower than 4 ohms may damage the unit.

Troubleshooting Guide

What might appear to be a malfunction in your unit may just be the result of slight misoperation or miswiring. Before calling service, first check the following table for possible problems.

PROBLEM	POSSIBLE CAUSE	SOLUTION
No sound. (No sound from one side.)	<ul style="list-style-type: none"> • Input (or output) cables are disconnected. • Protection circuit may be activated. • The fuse may be blown because the volume was too high. 	<ul style="list-style-type: none"> • Connect the input (or output) cables. • Check connections by referring to "Protection function". • Replace the fuse with a new fuse and use a lower volume.
The output level is too small (or too large).	The input sensitivity adjusting control is not set to the correct position.	Adjust the control correctly referring to "Controls".
The sound quality is bad. (The sound is distorted.)	<ul style="list-style-type: none"> • The speakers cable are connected with wrong \oplus / \ominus polarity. • A speaker cable is pinched by a screw in the car body. • The switches may be set improperly. 	<ul style="list-style-type: none"> • Connect them properly checking the \oplus / \ominus of the terminals and cables well. • Connect the speaker cable again so that it is not pinched by anything. • Set switches properly by referring to "System examples".

Specifications

Specifications subject to change without notice.

Audio Section	KAC-726	KAC-526X
Max Power Output (4 Ω)		
Normal	200 W \times 2	70 W \times 2
Bridge.....	600 W \times 1	200 W \times 1
Rated Power Output (4 Ω)		
Normal (DIN45324, +B=14.4 V)	100 W \times 2	35 W \times 2
Bridge (1 kHz, 0.8 % THD)	300 W \times 1	100 W \times 1
Rated Power Output (2 Ω)		
Normal (1 kHz, 0.8 % THD)	150 W \times 2	50 W \times 2
Frequency Response (+0, -1 dB)	5 Hz ~ 50 kHz	5 Hz ~ 50 kHz
Signal to Noise Ratio	100 dB	100 dB
Sensitivity (MAX) (rated output)	0.2 V	0.2 V
Sensitivity (MIN) (rated output)	5.0 V	5.0 V
Input Impedance.....	10 k Ω	10 k Ω
Low Pass Filter (12 dB/oct.)	80 Hz	80 Hz
General	KAC-726	KAC-526X
Operating Voltage (11 ~ 16 V allowable)	14.4 V	14.4 V
Current Consumption (1 kHz, 10% THD)	28 A	16 A
Dimensions (W \times H \times D).....	220 \times 52 \times 300 mm	220 \times 52 \times 160 mm
Weight	3.0 kg	1.6 kg